

## Crock de montagem Embraer 120 MR modelismo

Montagem do kit para montar.

1 – Junção das peças:

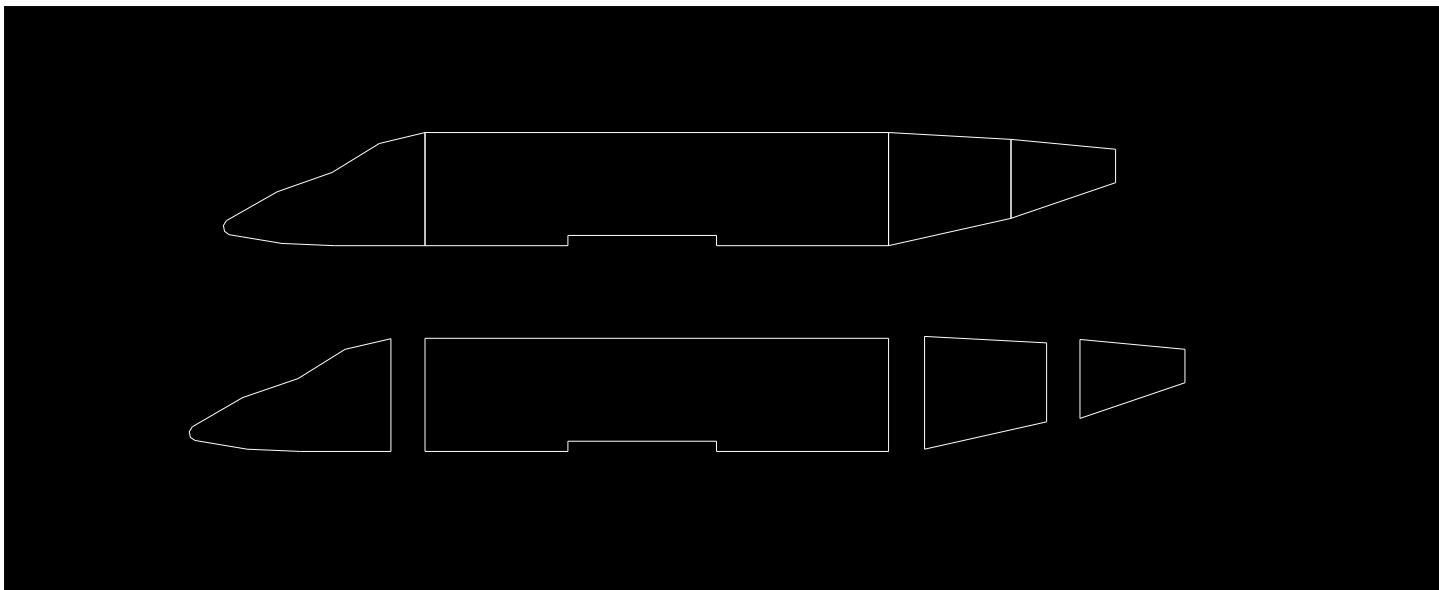

Sequencia com suporte da asa e e leme colocado:

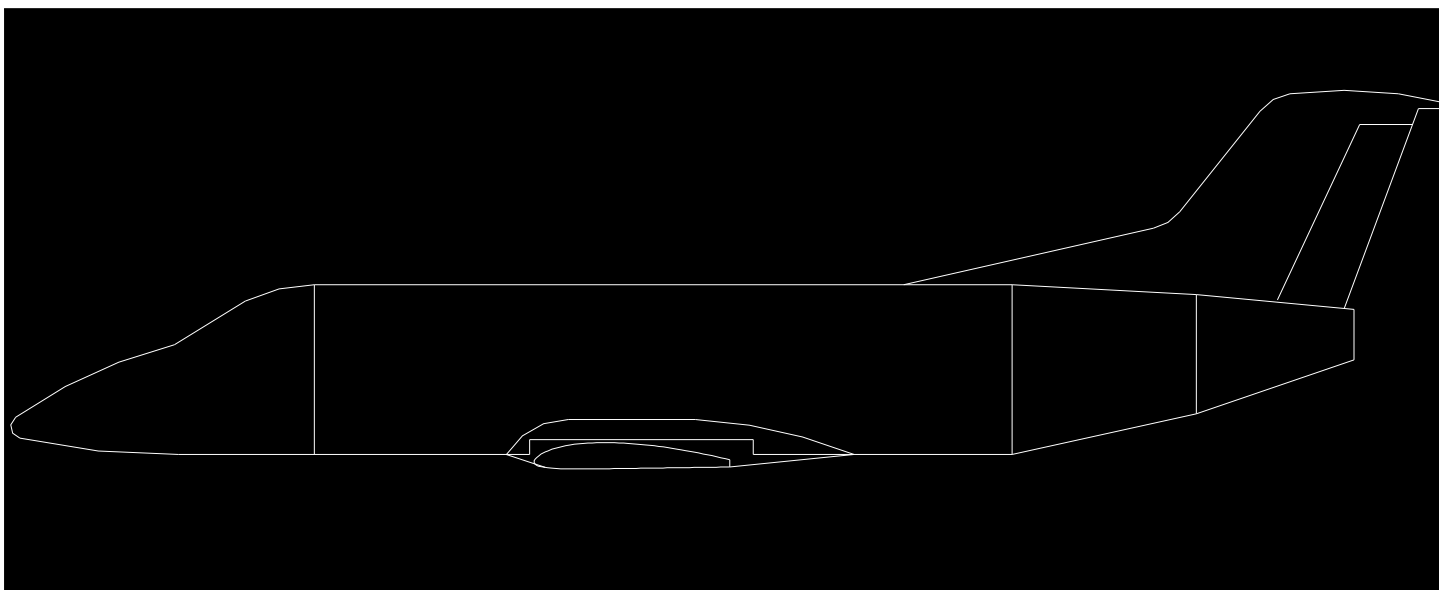

Fixação das naceles do motor:

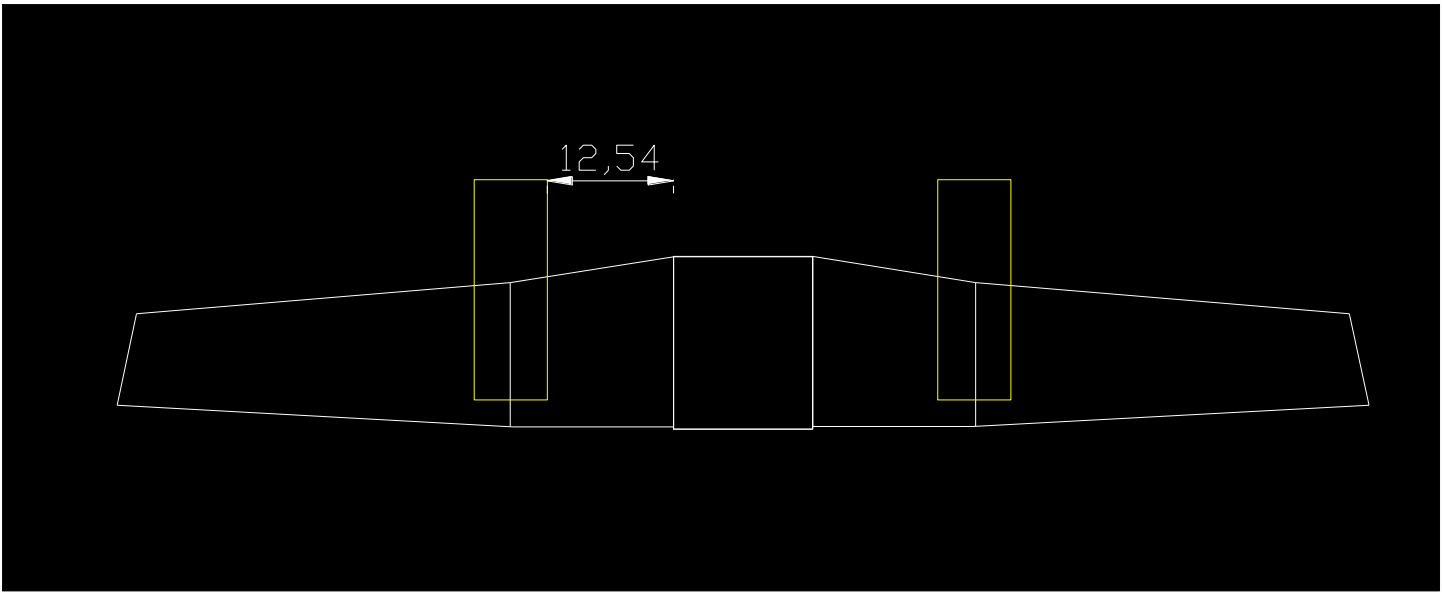

## Colocação da eletrônica:

Nesta primeira estapa, veremos a distribuição da eletrônica:

1 - Colagem leme e profundor , colocação de servos na cauda “ Leme e Profundor ”.

Posição de colagem:

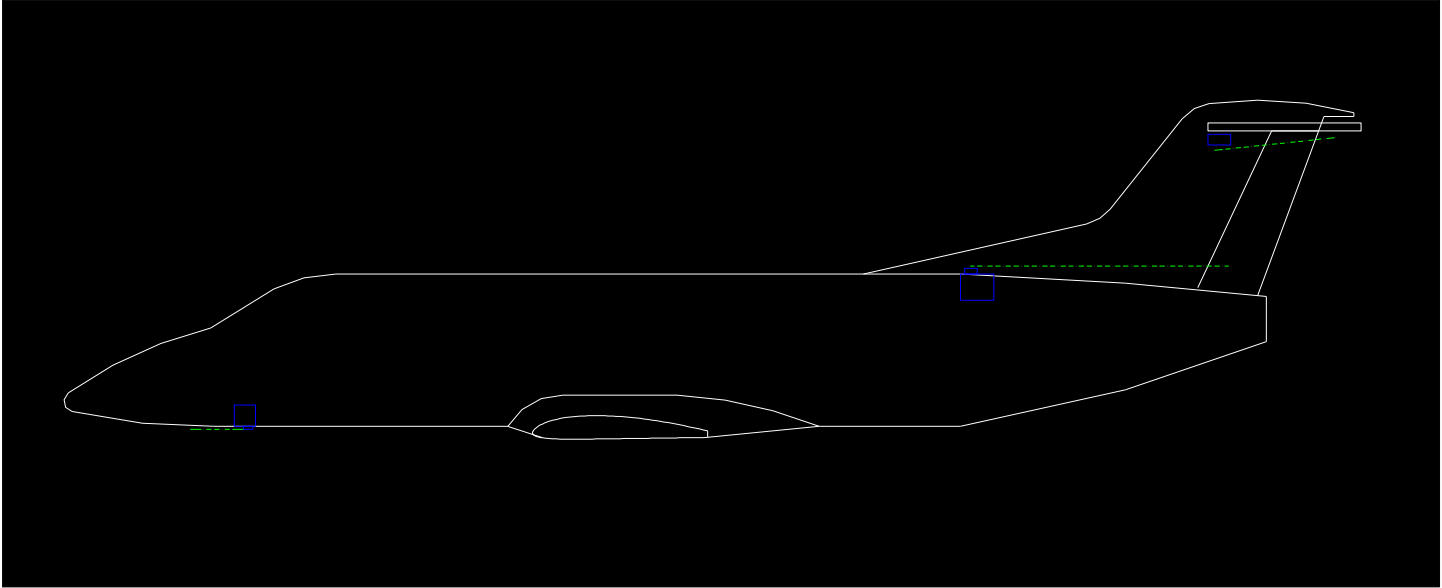

Linkagem servo aileron e distancia das turbinas:

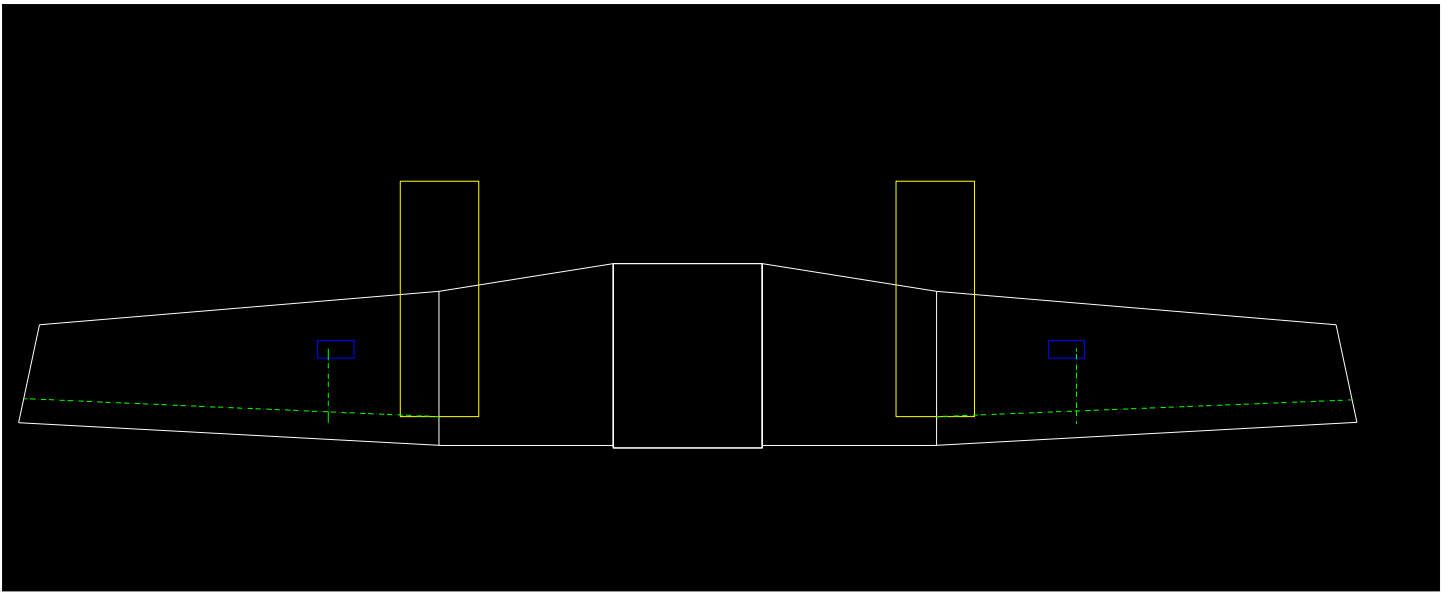

Fixação da asa esquema dos parafusos e madeiras.

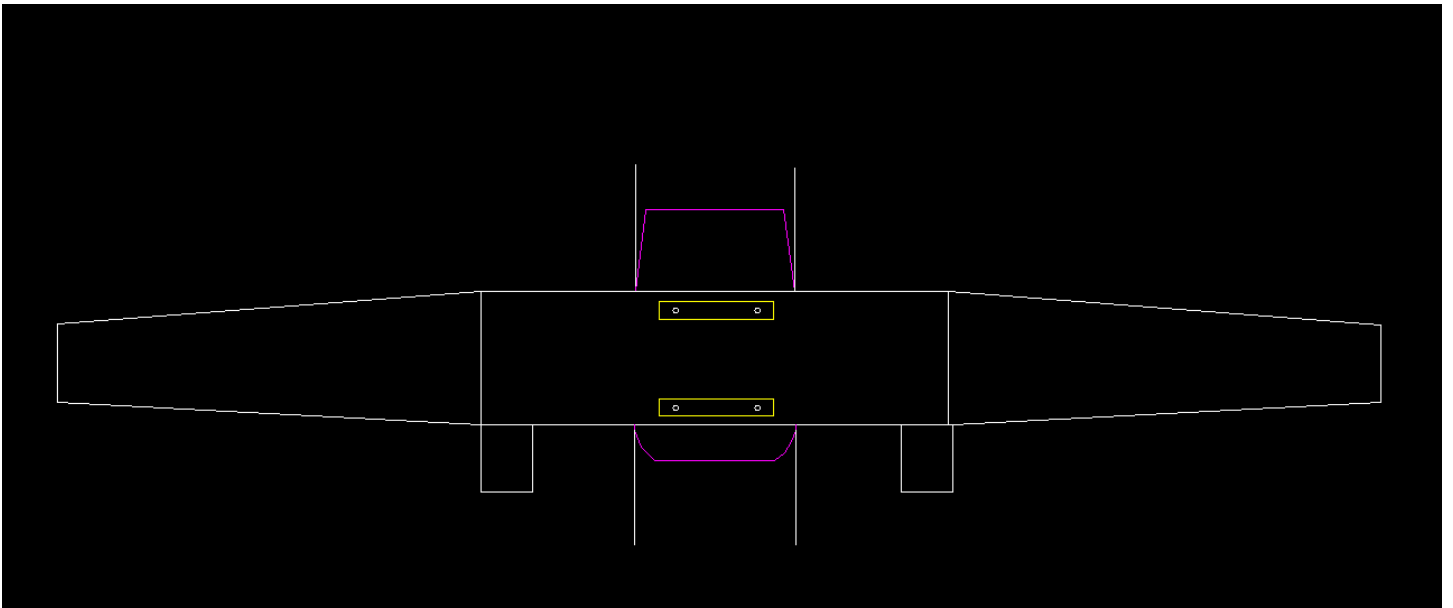
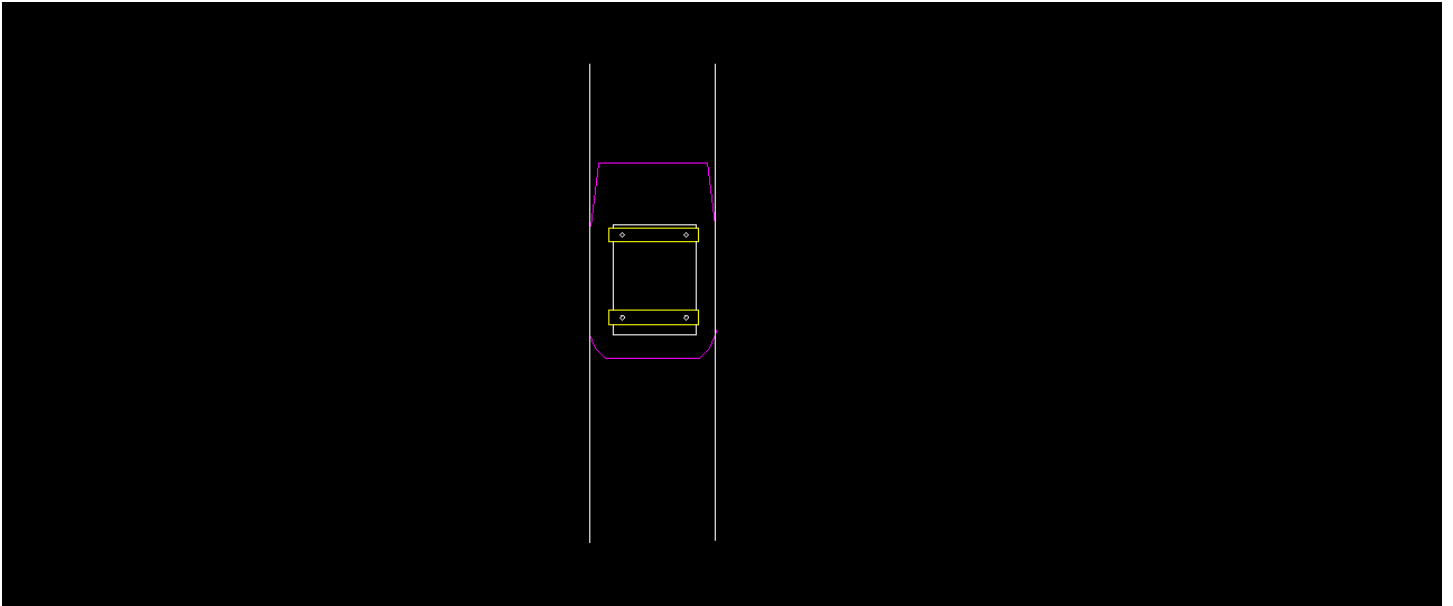

Distribuição da eletrônica e CG.

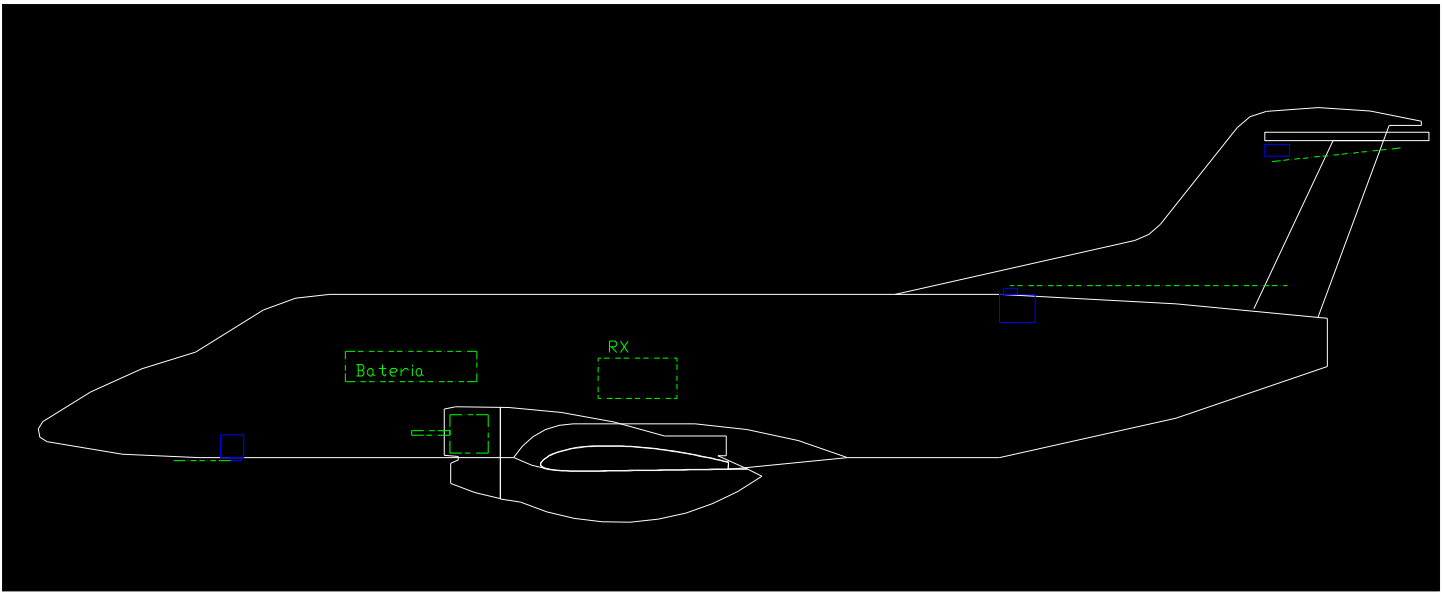

CG.

